

Lily Medical Infusion Series Catalogue



LILY infusion devices are single-use, sterile, and non-pyrogenic solutions. All infusion devices are non-DEHP without latex material and entirely compatible with lipid medication to meet most hospital needs and existing procedures.

Needleless Connector- Neutral Displacement

Needleless connector attach on device specifically features low reflux and low residue. It does not permit the use of needles, thereby enhancing compliance with needle-free practices.

Features

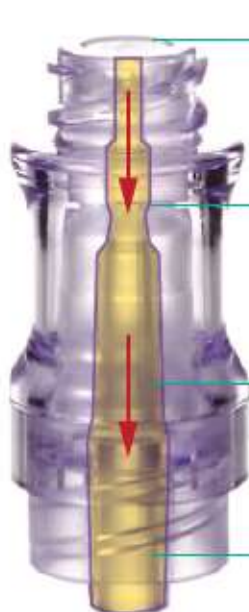

- **Flat Access Port with Slit Septum**
Easy to disinfect thoroughly per CDC recommended protocol [a] [b].
- **Gapless between Septum and Casing**
Mechanically provide an effective microbial barrier against bacteria contamination [c].
- **Internal Straight Fluid Pathway**
Specifically designed to minimize reflux and priming volume with low dead space.
- **Transparent Housing**
Visually confirm residue after medication and flush.

Performance

Technical Specification		Drug Compatibility	
Flow Rate at Gravity	170 ml/min	Alcohol	YES
Priming Volume	0.069 ml	Lipids	YES
Reflux Volume	0.0015 ml	Chlorhexidine	YES
Functional Activations	600	Antineoplastic Drugs ^(d)	YES
MRI Compatibility	YES	Blood Compatibility	YES
Free of Latex	YES		
Free of DEHP	YES		

LILY MEDICAL CORPORATION

No. 28-2, Shun Jean Diann, Chunan Town, Miaoli County, Taiwan. Tel:+886-37-612-625. www.Lily-medical.com

Drawings are not to be scaled. Information is subjected to be revised without further notice.

Lily Medical Infusion Series Catalogue



Needleless Connector

Neutral Displacement

		Approx. Priming Volume	Male Luer Type
--	--	---------------------------	-------------------

CIC-006SN



0.07 ml

Luer Lock



Stopcock

		Approx. Priming Volume	
--	--	---------------------------	--

CIC-010SN



0.37 ml

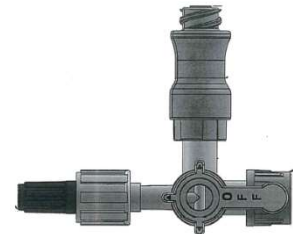

CIC-011SN



0.44 ml



LILY MEDICAL CORPORATION

No. 28-2, Shun Jean Diann, Chunan Town, Miaoli County, Taiwan. Tel:+886-37-612-625. www.Lily-medical.com

Drawings are not to be scaled. Information is subjected to be revised without further notice.



Infusion Volume Metric Administration Set

- Flow regulator for offering precision care and consistent delivery.
- Automatic shut-offswim valve to prevent air embolism.

100ml Burette

CIB-100NSE

Non-DEHP

LATEX

Nominal
Length

220 cm

I.D.

3.1 mm

Male Luer
Type

Slip

- Compatible with lipid.
- Neutral Needleless Connector.

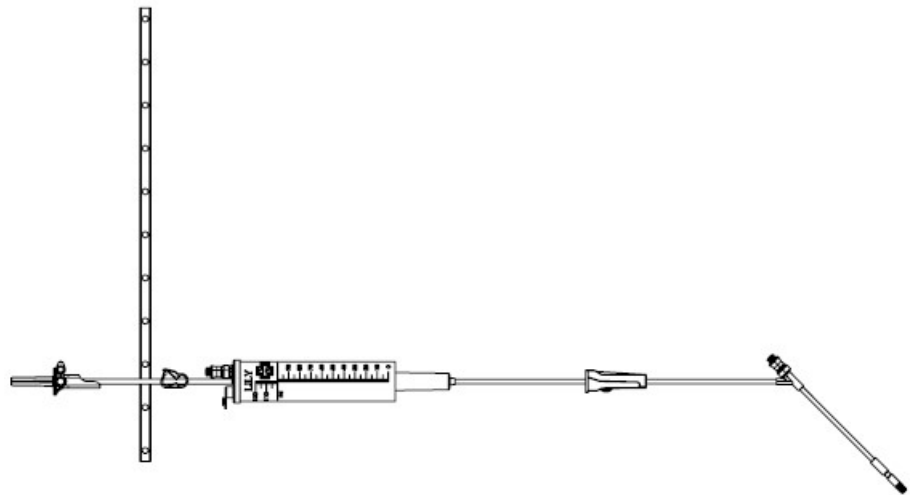

CIB-100NLE

Non-DEHP

LATEX

220 cm

3.1 mm

Rotating

- Compatible with lipid.
- Neutral Needleless Connector.

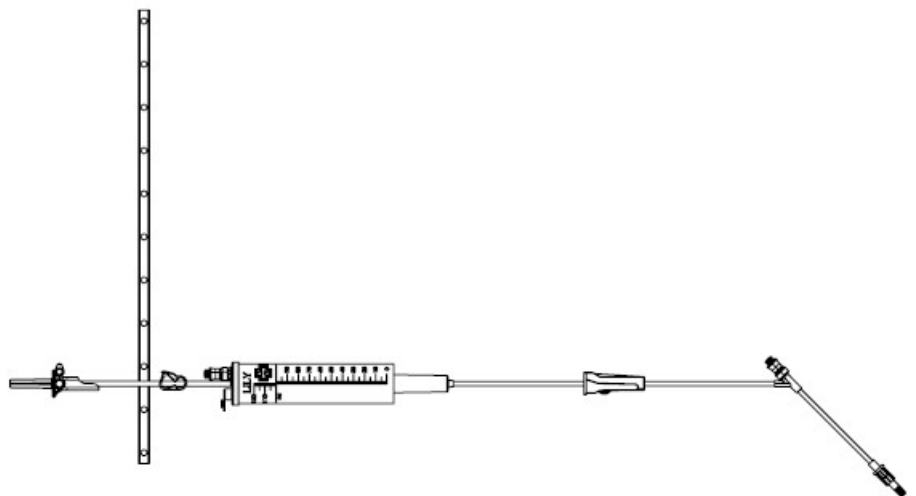

LILY MEDICAL CORPORATION

No. 28-2, Shun Jean Diann. Chunan Town. Miaoli County, Taiwan. Tel:+886-37-612-625. www.Lily-medical.com

Drawings are not to be scaled. Information is subjected to be revised without further notice.



Infusion Volume Metric Administration Set

- Flow regulator for offering precision care and consistent delivery.
- Automatic shut-offswim valve to prevent air embolism.

120ml Burette

	Nominal Length	I.D.	Male Luer Type
CIB-120NSE	220 cm	3.1 mm	Slip

Non-DEHP
LATEX

- Compatible with lipid.
- Neutral Needleless Connector.

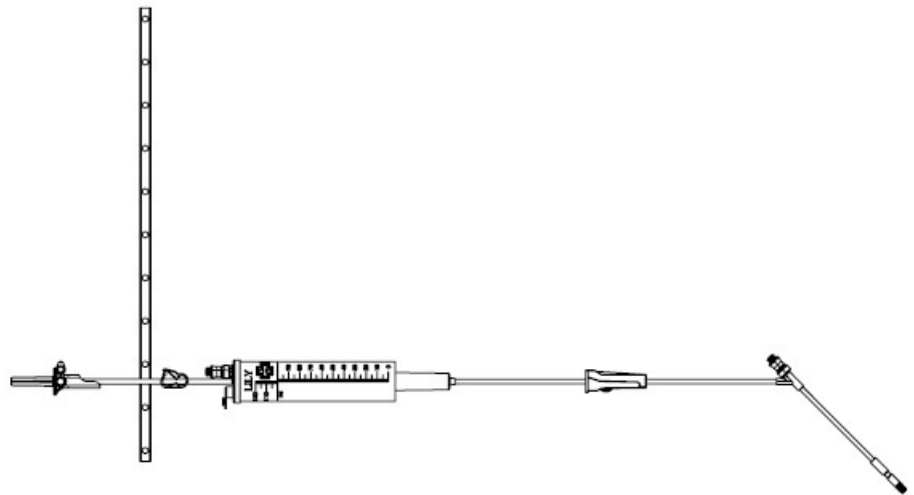

CIB-120NLE

Non-DEHP
LATEX

- Compatible with lipid.
- Neutral Needleless Connector.

220 cm 3.1 mm Rotating

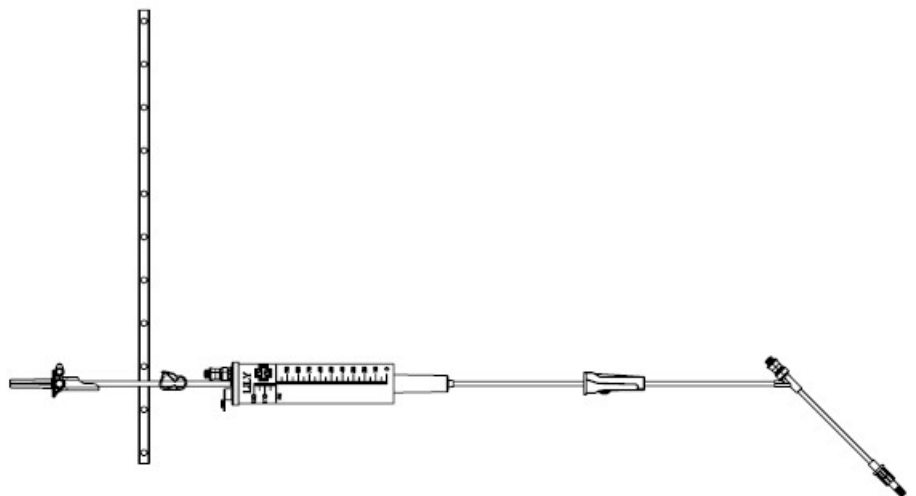

LILY MEDICAL CORPORATION

No. 28-2, Shun Jean Diann. Chunan Town. Miaoli County, Taiwan. Tel:+886-37-612-625. www.Lily-medical.com

Drawings are not to be scaled. Information is subjected to be revised without further notice.



Infusion Volume Metric Administration Set

- Flow regulator for offering precision care and consistent delivery.
- Automatic shut-offswim valve to prevent air embolism.

150ml Burette	Nominal Length	I.D.	Male Luer Type
---------------	----------------	------	----------------

CIB-150NSE	220 cm	3.1 mm	Slip
------------	--------	--------	------

Non-DEHP
LATEX

- Compatible with lipid.
- Neutral Needleless Connector.

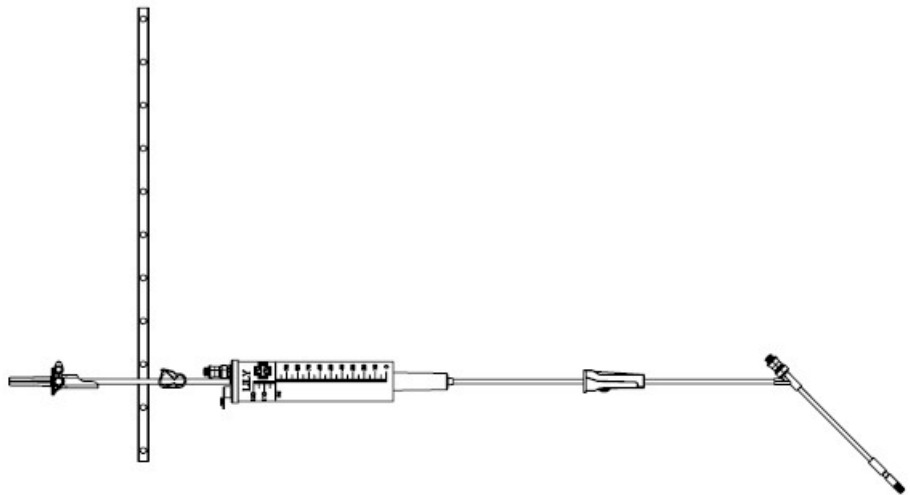

CIB-150NLE	220 cm	3.1 mm	Rotating
------------	--------	--------	----------

Non-DEHP
LATEX

- Compatible with lipid.
- Neutral Needleless Connector.

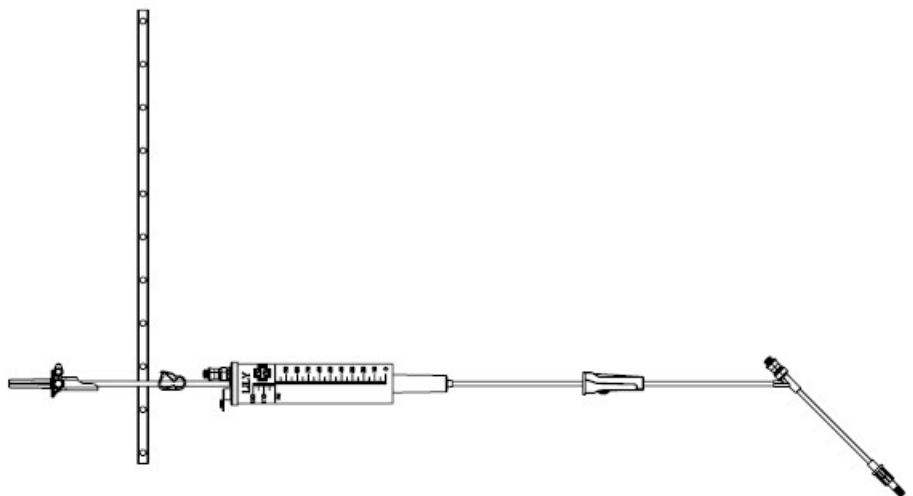

LILY MEDICAL CORPORATION

No. 28-2, Shun Jean Diann, Chunan Town, Miaoli County, Taiwan. Tel:+886-37-612-625. www.Lily-medical.com

Drawings are not to be scaled. Information is subjected to be revised without further notice.

Lily Medical Infusion Series Catalogue



I.V. Administration Set

- Flow regulator for offering precision care and consistent delivery.

20 Drops/ ml

		Nominal Length	I.D.	Male Luer Type
CIV-180NSE	<div style="border: 1px solid black; padding: 2px; display: inline-block;">Non-DEHP</div> <div style="border: 1px solid black; padding: 2px; display: inline-block;">LATEX</div>	192 cm	3.1 mm	Slip

- Compatible with lipid.
- Neutral Needleless Connector.

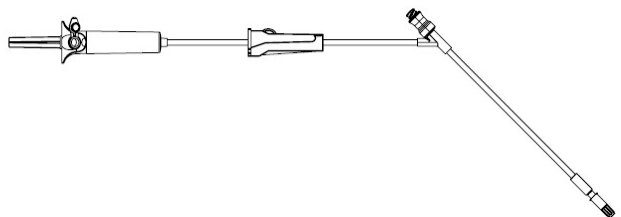

CIV-180NLE	<div style="border: 1px solid black; padding: 2px; display: inline-block;">Non-DEHP</div> <div style="border: 1px solid black; padding: 2px; display: inline-block;">LATEX</div>	192 cm	3.1 mm	Rotating
------------	---	--------	--------	----------

- Compatible with lipid.
- Neutral Needleless Connector.

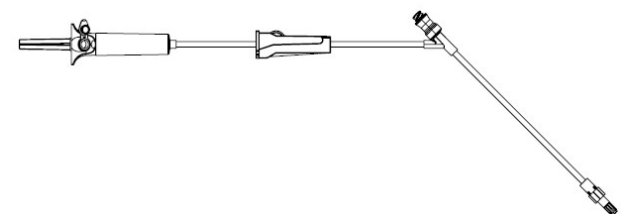

60 Drops/ ml

		Nominal Length	I.D.	Male Luer Type
CIV-165NSM	<div style="border: 1px solid black; padding: 2px; display: inline-block;">Non-DEHP</div> <div style="border: 1px solid black; padding: 2px; display: inline-block;">LATEX</div>	192 cm	3.1 mm	Slip

- Compatible with lipid.
- Neutral Needleless Connector.

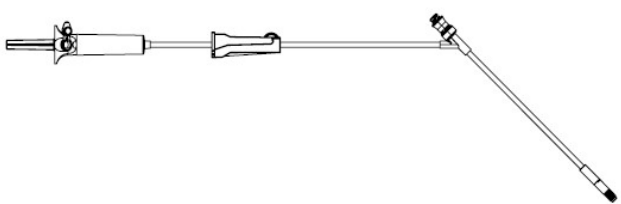

CIV-165NLM	<div style="border: 1px solid black; padding: 2px; display: inline-block;">Non-DEHP</div> <div style="border: 1px solid black; padding: 2px; display: inline-block;">LATEX</div>	192 cm	3.1 mm	Rotating
------------	---	--------	--------	----------

- Compatible with lipid.
- Neutral Needleless Connector.

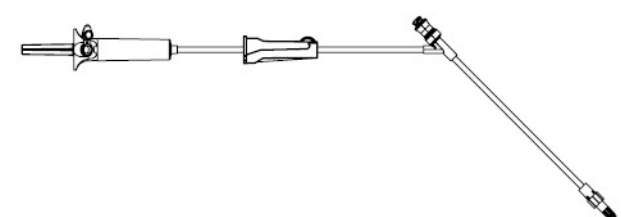

LILY MEDICAL CORPORATION

No. 28-2, Shun Jean Diann. Chunan Town. Miaoli County, Taiwan. Tel:+886-37-612-625. www.Lily-medical.com

Drawings are not to be scaled. Information is subjected to be revised without further notice.

Lily Medical Infusion Series Catalogue



I.V. Extension Tube

One Way

		Approx. Priming Volume	Nominal Length	I.D.	Male Luer Type
CET-TS02S0	<div style="background-color: black; color: white; padding: 2px; display: inline-block;">Non-DEHP</div> <div style="border: 1px solid black; padding: 2px; display: inline-block;">LATEX</div>	1.27ml	15 cm	3.1 mm	Rotating
<ul style="list-style-type: none"> ● Compatible with lipid. ● Neutral Needleless Connector. 					
CET-TS02L0	<div style="background-color: black; color: white; padding: 2px; display: inline-block;">Non-DEHP</div> <div style="border: 1px solid black; padding: 2px; display: inline-block;">LATEX</div>	1.27ml	15 cm	3.1 mm	Slip
<ul style="list-style-type: none"> ● Compatible with lipid. ● Neutral Needleless Connector. 					
CET-SS02S0	<div style="background-color: black; color: white; padding: 2px; display: inline-block;">Non-DEHP</div> <div style="border: 1px solid black; padding: 2px; display: inline-block;">LATEX</div>	0.34ml	15 cm	1.27 mm	Rotating
<ul style="list-style-type: none"> ● Compatible with lipid. ● Neutral Needleless Connector. 					
CET-SS02L0	<div style="background-color: black; color: white; padding: 2px; display: inline-block;">Non-DEHP</div> <div style="border: 1px solid black; padding: 2px; display: inline-block;">LATEX</div>	0.34ml	15 cm	1.27 mm	Slip
<ul style="list-style-type: none"> ● Compatible with lipid. ● Neutral Needleless Connector. 					

LILY MEDICAL CORPORATION



No. 28-2, Shun Jean Diann, Chunan Town, Miaoli County, Taiwan. Tel:+886-37-612-625. www.Lily-medical.com

Drawings are not to be scaled. Information is subjected to be revised without further notice.

Lily Medical Infusion Series Catalogue

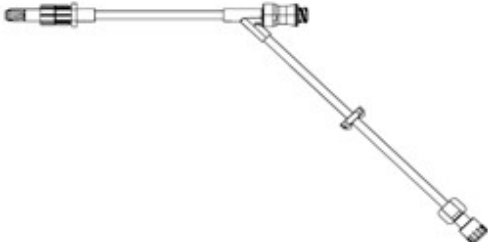
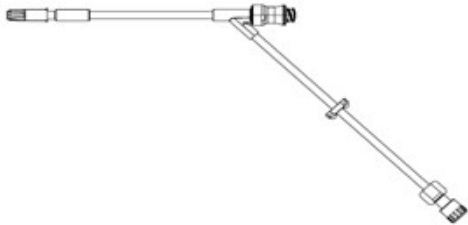

I.V. Extension Tube

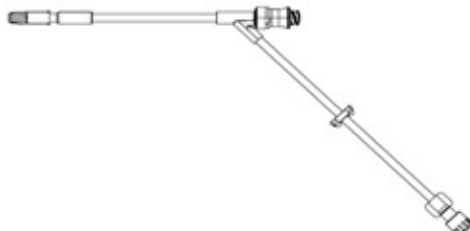
Y-Site		Approx. Priming Volume	Nominal Length	I.D.	Male Luer Type
CET-TY10S0	<div style="border: 1px solid black; padding: 2px; display: inline-block;">Non-DEHP</div> <div style="border: 1px solid black; padding: 2px; display: inline-block;">LATEX</div>	1.58ml	22 cm	3.1 mm	Rotating
	<ul style="list-style-type: none"> ● Compatible with lipid. ● Neutral Needleless Connector. 				
CET-TY10L0	<div style="border: 1px solid black; padding: 2px; display: inline-block;">Non-DEHP</div> <div style="border: 1px solid black; padding: 2px; display: inline-block;">LATEX</div>	1.58ml	22 cm	3.1 mm	Slip
	<ul style="list-style-type: none"> ● Compatible with lipid. ● Neutral Needleless Connector. 				
CET-SY10S0	<div style="border: 1px solid black; padding: 2px; display: inline-block;">Non-DEHP</div> <div style="border: 1px solid black; padding: 2px; display: inline-block;">LATEX</div>	0.39ml	22 cm	1.27 mm	Rotating
	<ul style="list-style-type: none"> ● Compatible with lipid. ● Neutral Needleless Connector. 				
CET-SY10L0	<div style="border: 1px solid black; padding: 2px; display: inline-block;">Non-DEHP</div> <div style="border: 1px solid black; padding: 2px; display: inline-block;">LATEX</div>	0.39ml	22 cm	1.27 mm	Slip
	<ul style="list-style-type: none"> ● Compatible with lipid. ● Neutral Needleless Connector. 				

LILY MEDICAL CORPORATION

No. 28-2, Shun Jean Diann, Chunan Town, Miaoli County, Taiwan. Tel:+886-37-612-625. www.Lily-medical.com

Drawings are not to be scaled. Information is subjected to be revised without further notice.

Lily Medical Infusion Series Catalogue



I.V. Extension Tube

Dual-Site		Approx. Priming Volume	Nominal Length	I.D.	Male Luer Type
CET-TD02S0	<div style="background-color: black; color: white; padding: 2px; display: inline-block;">Non-DEHP</div> <div style="border: 1px solid black; padding: 2px; display: inline-block;">LATEX</div>	1.28ml	15 cm	2.5 mm	Rotating
<ul style="list-style-type: none"> ● Compatible with lipid. ● Neutral Needleless Connector. 					
CET-TD02L0	<div style="background-color: black; color: white; padding: 2px; display: inline-block;">Non-DEHP</div> <div style="border: 1px solid black; padding: 2px; display: inline-block;">LATEX</div>	1.28ml	15 cm	2.5 mm	Slip
<ul style="list-style-type: none"> ● Compatible with lipid. ● Neutral Needleless Connector. 					
CET-SD02S0	<div style="background-color: black; color: white; padding: 2px; display: inline-block;">Non-DEHP</div> <div style="border: 1px solid black; padding: 2px; display: inline-block;">LATEX</div>	0.47ml	15 cm	1.27 mm	Rotating
<ul style="list-style-type: none"> ● Compatible with lipid. ● Neutral Needleless Connector. 					
CET-SD02L0	<div style="background-color: black; color: white; padding: 2px; display: inline-block;">Non-DEHP</div> <div style="border: 1px solid black; padding: 2px; display: inline-block;">LATEX</div>	0.47ml	15 cm	1.27mm	Slip
<ul style="list-style-type: none"> ● Compatible with lipid. ● Neutral Needleless Connector. 					

LILY MEDICAL CORPORATION

No. 28-2, Shun Jean Diann, Chunan Town, Miaoli County, Taiwan. Tel:+886-37-612-625. www.Lily-medical.com

Drawings are not to be scaled. Information is subjected to be revised without further notice.

Lily Medical Infusion Series Catalogue

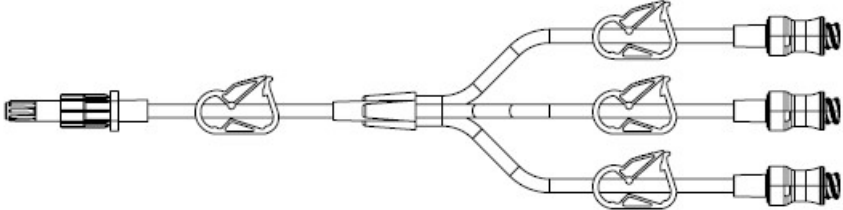
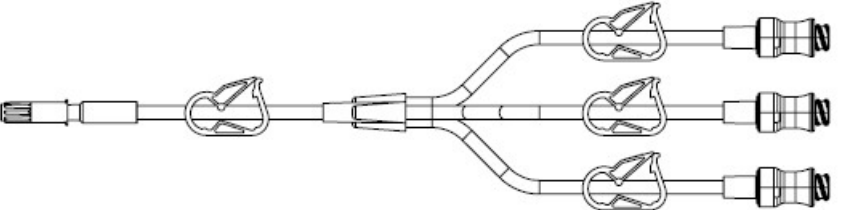
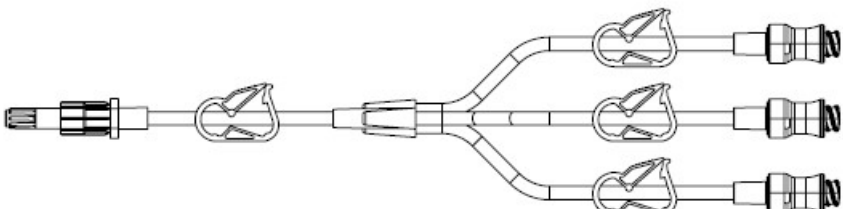
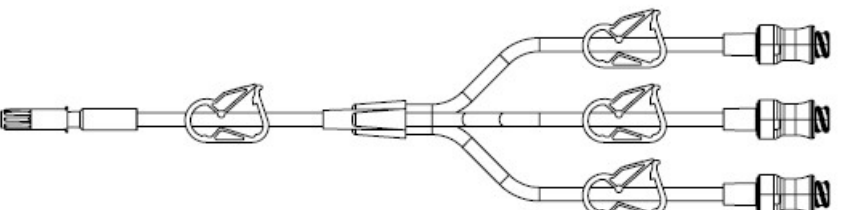

I.V. Extension Tube

Triple -Site	Approx. Priming Volume	Nominal Length	I.D.	Male Luer Type
CET-TM32S0 <div style="display: flex; align-items: center; gap: 5px;"> <div style="border: 1px solid black; padding: 2px; background-color: #333; color: white; font-size: 8px;">Non-DEHP</div> <div style="border: 1px solid black; padding: 2px; background-color: #eee; font-size: 8px;">LATEX</div> </div> <ul style="list-style-type: none"> ● Compatible with lipid. ● Neutral Needleless Connector. 	1.82ml	15 cm	3.1 mm	Rotating
CET-TM32L0 <div style="display: flex; align-items: center; gap: 5px;"> <div style="border: 1px solid black; padding: 2px; background-color: #333; color: white; font-size: 8px;">Non-DEHP</div> <div style="border: 1px solid black; padding: 2px; background-color: #eee; font-size: 8px;">LATEX</div> </div> <ul style="list-style-type: none"> ● Compatible with lipid. ● Neutral Needleless Connector. 	1.82ml	15 cm	3.1 mm	Slip
CET-SM32S0 <div style="display: flex; align-items: center; gap: 5px;"> <div style="border: 1px solid black; padding: 2px; background-color: #333; color: white; font-size: 8px;">Non-DEHP</div> <div style="border: 1px solid black; padding: 2px; background-color: #eee; font-size: 8px;">LATEX</div> </div> <ul style="list-style-type: none"> ● Compatible with lipid. ● Neutral Needleless Connector. 	0.65ml	15 cm	1.27 mm	Rotating
CET-SM32L0 <div style="display: flex; align-items: center; gap: 5px;"> <div style="border: 1px solid black; padding: 2px; background-color: #333; color: white; font-size: 8px;">Non-DEHP</div> <div style="border: 1px solid black; padding: 2px; background-color: #eee; font-size: 8px;">LATEX</div> </div> <ul style="list-style-type: none"> ● Compatible with lipid. ● Neutral Needleless Connector. 	0.65ml	15 cm	1.27 mm	Slip

LILY MEDICAL CORPORATION

No. 28-2, Shun Jean Diann, Chunan Town, Miaoli County, Taiwan. Tel:+886-37-612-625. www.Lily-medical.com

Drawings are not to be scaled. Information is subjected to be revised without further notice.

Lily Medical Infusion Series Catalogue



I.V. Extension Tube

Qual -Site	Approx. Priming Volume	Nominal Length	I.D.	Male Luer Type
CET-TM42S0 <div style="display: flex; align-items: center; gap: 5px;"> <div style="border: 1px solid black; padding: 2px; font-size: 8px;">Non-DEHP</div> <div style="border: 1px solid black; padding: 2px; font-size: 8px;">LATEX</div> </div> <ul style="list-style-type: none"> ● Compatible with lipid. ● Neutral Needleless Connector. 	2.56ml	19 cm	2.5 mm	Rotating
CET-TM42L0 <div style="display: flex; align-items: center; gap: 5px;"> <div style="border: 1px solid black; padding: 2px; font-size: 8px;">Non-DEHP</div> <div style="border: 1px solid black; padding: 2px; font-size: 8px;">LATEX</div> </div> <ul style="list-style-type: none"> ● Compatible with lipid. ● Neutral Needleless Connector. 	2.56ml	19 cm	2.5 mm	Slip
CET-SM42S0 <div style="display: flex; align-items: center; gap: 5px;"> <div style="border: 1px solid black; padding: 2px; font-size: 8px;">Non-DEHP</div> <div style="border: 1px solid black; padding: 2px; font-size: 8px;">LATEX</div> </div> <ul style="list-style-type: none"> ● Compatible with lipid. ● Neutral Needleless Connector. 	1.16ml	19 cm	1.27 mm	Rotating
CET-SM42L0 <div style="display: flex; align-items: center; gap: 5px;"> <div style="border: 1px solid black; padding: 2px; font-size: 8px;">Non-DEHP</div> <div style="border: 1px solid black; padding: 2px; font-size: 8px;">LATEX</div> </div> <ul style="list-style-type: none"> ● Compatible with lipid. ● Neutral Needleless Connector. 	1.16ml	19 cm	1.27 mm	Slip

LILY MEDICAL CORPORATION

No. 28-2, Shun Jean Diann. Chunan Town. Miaoli County, Taiwan. Tel:+886-37-612-625. [www. Lily-medical.com](http://www.Lily-medical.com)

Drawings are not to be scaled. Information is subjected to be revised without further notice.

Lily Medical Infusion Series Catalogue



I.V. Extension Tube

T -Site	Approx. Priming Volume	Nominal Length	I.D.	Male Luer Type
---------	------------------------	----------------	------	----------------

CET-ST10L0	0.34ml	15 cm	1.27 mm	Slip
------------	--------	-------	---------	------

Non-DEHP
LATEX

- Compatible with lipid.
- Neutral Needleless Connector.

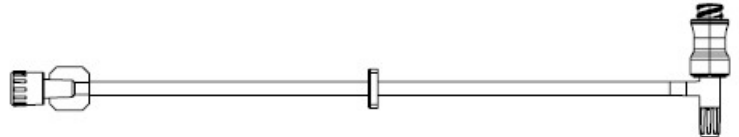

Dual-Y-Site	Approx. Priming Volume	Nominal Length	I.D.	Male Luer Type
-------------	------------------------	----------------	------	----------------

CET-TY20L0	1.10ml	22 cm	2.3 mm	Slip
------------	--------	-------	--------	------

Non-DEHP
LATEX

- Compatible with lipid.
- Neutral Needleless Connector.

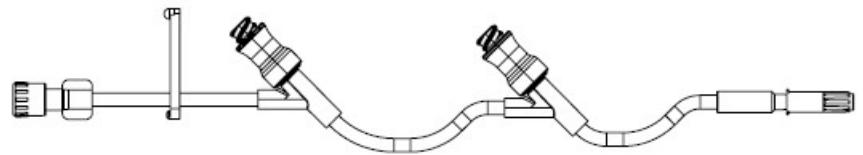

CET-TY20S0	1.10ml	22cm	2.3 mm	Rotating
------------	--------	------	--------	----------

Non-DEHP
LATEX

- Compatible with lipid.
- Neutral Needleless Connector.

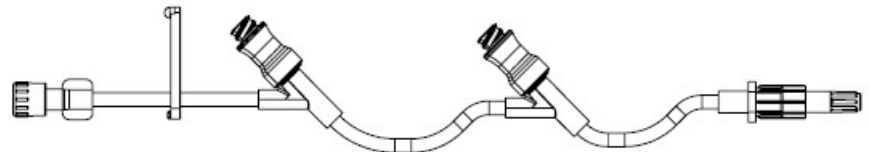

LILY MEDICAL CORPORATION

No. 28-2, Shun Jean Diann. Chunan Town. Miaoli County, Taiwan. Tel:+886-37-612-625. www.Lily-medical.com

Drawings are not to be scaled. Information is subjected to be revised without further notice.